

Is Your Home Protected



From Wildfire Disaster?



A Homeowner's Guide
to Wildfire Retrofit

acknowledgments

The staff of the Institute for Business & Home Safety (IBHS) wishes to acknowledge the valuable input of all those involved in the preparation of this booklet. In particular, we extend our thanks to:

The IBHS Wildfire Committee Members
National Fire Protection Association
State Farm Fire and Casualty Company
National Institute of Standards & Technology
US Geological Survey
Insurance Services Office, Inc.
The Hartford Financial Services Group
California FAIR Plan Association
Allstate Insurance Company

Architectural Illustrations:
W. Spaulding, AIA

Photography:
Cover: Incident scenes; post-burn/damages
Courtesy National Interagency Fire Center, Boise, Idaho
Cover and page 1: Bitterroot National Forest, Montana
Courtesy National Interagency Fire Center, Boise, Idaho
Cover and page 2: Pine Barrens
© J Smalley, NJ
Opposite Table of Contents: Florida Wildfire
© AP/Wide World Photos

Disclaimer

The purpose of this document is to provide homeowners with guidance on ways to retrofit and build homes to reduce losses from wildfire damage. It contains suggestions and recommendations based on professional judgment, experience and research and is intended to serve only as a guide. The authors, contributors and publisher disclaim all warranties and guarantees with respect to the information in the document and assume no liability or responsibility with respect to the information.

“Nature...she pardons no mistakes.”

Ralph Waldo Emerson



© AP/Wide World Photos

An April 2001 Florida wildfire caused Olga Gutierrez to desperately fight a fire behind her Port Charlotte, FL home with water from her pool.

In 1993, a wildfire in a dry canyon north of Laguna Beach, California, raced toward hundreds of nearby homes, giving residents little advance warning of its awesome destruction. More than 14,000 acres and 440 homes went up in flames.

In the nearby Mystic Hills neighborhood, 286 homes were totally destroyed. Yet, there was one white house left standing in the midst of hundreds of piles of smoking ash that remained of its neighboring homes. This sole surviving house was built with fire prevention in mind. It stood as an example of how homes can, with a little extra attention, better withstand nature's perils. The practical methods used in and around that house can help reduce the chances of future wildfires from reducing communities to ashes. This guide is designed to make that one rare exception of survival a more common occurrence in the future.

table of contents

Introduction	1
Wildfires and Your Home	2
The Wildland/Urban Interface Problem.....	2
You and Your Local Fire Department.....	2
Just the Right Conditions.....	3
How Your Home Catches Fire.....	4
Taking Inventory - Is your property at risk?	4
What's Your Risk Level?	5
What You Can Do to Reduce Your Risk.....	5
Your Home's Landscape	7
Creating a Survivable Space.....	7
The Importance of Maintenance.....	7
Your Home's Building Materials and Design	8
The Ideal Fire-Resistant Home	8
Taking Inventory	8
Taking Action.....	9
Helping Your Local Fire Department	12
Wildfire Safety Project List	13
Wildfire Protection Checklist	14
References	19
Additional Sources of Information	20

Large Fire Locations

January 1 to October 3, 2000



*Courtesy National Interagency Fire Center
Boise, Idaho*

introduction

Nearly every state has been devastated by wildfires in the last century. More than 140,000 wildfires occur on average each year. Since 1990, more than 900 homes have been destroyed each year by wildfires.

So, what can you do to protect yourself, your home and property from wildfires? This guide will help you understand

- why your home is at risk, and
- how you can reduce the risk to your home and property.



*Bitterroot National Forest, Montana
John McColgan
FairBanks, AK • August 6, 2000*

wildfires and your home

The Wildland/Urban Interface Problem

Wildfires occur regularly. Whether started by humans or by lightning, they are part of a natural cycle that helps to maintain the health of our forests. Today, more than ever, people are moving into remote areas, with the desire to "get back to nature," without addressing the dangers that exist around them.

A tremendous wildfire danger exists where homes blend together with the wildland, creating the wildland/urban interface. The addition of homes there interrupts the natural cycle of wildfires. Ultimately,

this contributes to a dangerous build-up of old vegetation, leading to an uncontrollable wildfire.

You and Your Local Fire Department

In a wildfire, your local fire department has two priorities – to remove you and your family from harm's way and to stop the progression of the wildfire. If your home happens to be in the wildfire's path, they may or may not be able to protect it – there are simply no guarantees.

Consequently, you must take action before a fire starts.



© J Smalley, NJ • Pine Barrens

Just the Right Conditions

Conditions must be just right for a wildfire to start and spread. Specifically, fuel, weather and topography work together to determine how quickly a wildfire travels and at what intensity.

Fuels: The two basic fuel types in the wildland/urban interface are vegetation and structures.

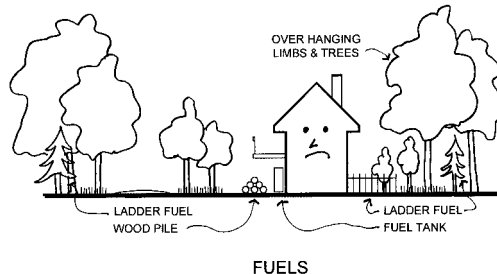

Vegetation: Fuel in its natural form consists of living and dead trees, bushes and grasses. Typically, grasses burn more quickly and with less intensity than trees. Any branches or shrubs between 18 inches and 6 feet are considered to be ladder fuels. Ladder fuels help convert a ground fire to a crown fire (tree tops) which moves much more quickly.

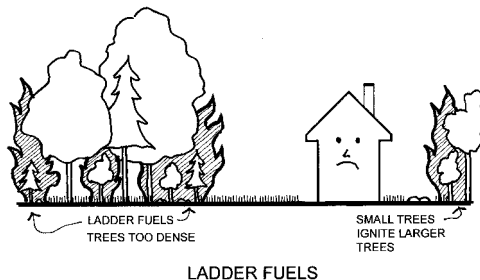

Structural Density: The closer the homes are together, the easier it is for the flames to spread from one structure to another.

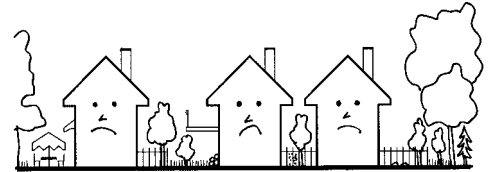

STRUCTURAL DENSITY

Weather: High temperatures, low humidity, and swift winds increase the probability of ignitions and difficulty of control. Short and long-term drought further exacerbates the problem.

Slope: Slope is the upward or downward incline or slant of terrain. For example, a completely flat plain represents a 0% slope and a hillside that rises 30 feet for every 100 feet horizontal distance represents a 30% slope.

Hot gases rise in front of the fire along the slope face, pre-heating the up-slope vegetation, moving a grass fire up to four times faster with flames twice as long as a fire on level ground.

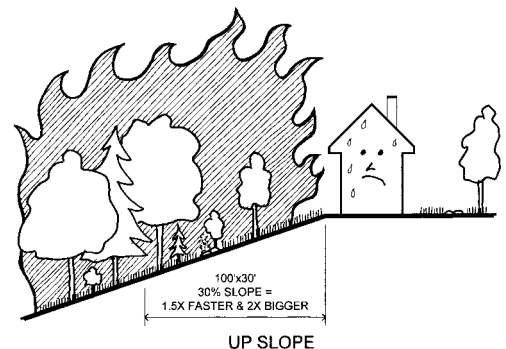

How Your Home Catches Fire

There are three ways that the wildfire can transfer itself from the natural vegetation or other burning homes to your home – through radiation, convection or firebrands.

Radiation: Wildfires can spread to your home by radiating heat in the same way a radiator heats your rooms in the wintertime. Radiated heat is capable of igniting combustible materials from distances of 100 feet or more.

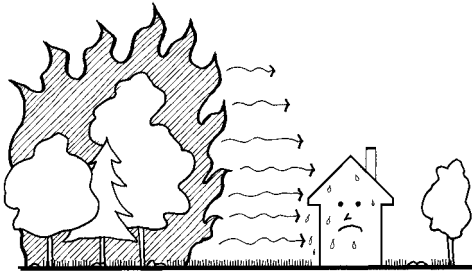

RADIATION

Convection: Contact with the convection column (flames) may also cause the wildfire to ignite your house. Typically, the convec-

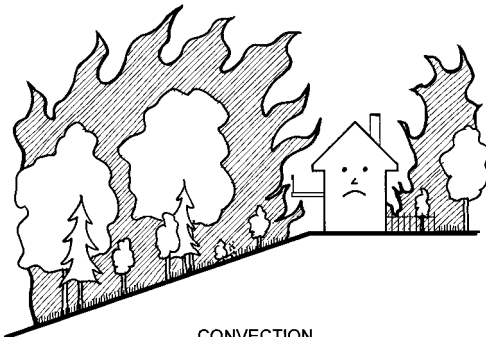

CONVECTION

tive heat column rises vertically, within the smoke plume.

Firebrands: Firebrands are burning materials that detach from a fire during strong convection drafts in the burning zone. Firebrands can be carried long distances – more than a mile – by the winds associated with the wildfire.



FIREBRANDS

In all cases, your home's building materials and design play a significant role in establishing the level of exposure that can be endured before ignition from radiation, convection, firebrands or any combination of these three.

Taking Inventory – Is Your Property at Risk?

The first step in establishing your risk is to assess your property. The table on page 5 lists numerous factors and issues that you should consider.

This assessment will give you a good sense of your property's wildfire risk.

Assessing Your Property

- | | |
|--|--|
| <input type="checkbox"/> Have wildfires occurred in your area? If so, under what conditions? | <input type="checkbox"/> Is there a substantial amount of tall vegetation crowded in around your home? |
| <input type="checkbox"/> Do you have seasons when wildfires are more likely to occur? | <input type="checkbox"/> Do tree limbs extend over your home? |
| <input type="checkbox"/> Do you live in hilly or flat country? | <input type="checkbox"/> Are the trees in good condition or are they dying? |
| <input type="checkbox"/> Are there areas around your home that are more susceptible to a wildfire? | <input type="checkbox"/> Do you have a woodpile in close proximity to your home? |
| <input type="checkbox"/> Do you border wildland? | <input type="checkbox"/> Do you have any fuel tanks nearby? |
| <input type="checkbox"/> Have you used native vegetation in your landscaping? | <input type="checkbox"/> Is a wood fence attached to your home? |

What's Your Risk Level?

The rough categories that follow on page 6 are not meant to give you an absolute score, but are to help guide you when deciding how to best protect your home.

What You Can Do To Reduce Your Risk

Homes in a wildland/urban interface area can be designed and maintained to increase the chances of surviving a wildfire without the intervention of the fire department.

This guide will help you protect your home on two different fronts:

- Your Home's Landscape
- Your Home's Building Materials and Design

Low Risk Areas:

- Little or no history of nearby wildfires
- Humid climate, short dry season
- Flat terrain (no grades greater than 9%)
- Limited wildland
- Home not crowded by trees
- Landscape includes native vegetation
- Manmade fuels at least 50 feet from your home.
- Fire hydrant within 300 feet
- Easy access for fire trucks

Moderate Risk Areas:

- History of wildfires
- Climate includes a dry season less than 3 months
- Hilly terrain (grades average between 10% and 20%)
- Bordering a wildland with light brush, small trees or grass
- Trees are located in close proximity to your home
- Native vegetation has or has not been incorporated into your landscape
- Manmade fuels are within 50 feet of your home
- Fire hydrant within 500 feet
- Access for fire trucks

High Risk Areas:

- History of nearby wildfires
- Dry climate with a dry season more than 3 months
- Steep terrain (grades average over 20%)
- Forested wildland within 100 feet of your home
- Native vegetation has not been incorporated into your landscape
- Trees are crowded within 30 feet of your home
- Manmade fuels within 30 feet of your home
- No fire hydrants
- Limited access for fire trucks

your home's landscape

Creating a Survivable Space For Your Home

A survivable space is an area of reduced fuels between your home and the untouched wildland. This provides enough distance between the home and a wildfire to ensure that the home can survive without extensive effort from either you or the fire department.

One of the easiest ways to establish a survivable space is to use the zone concept. Zone 1 is the closest to your home and Zones 2 and 3 move progressively further away.

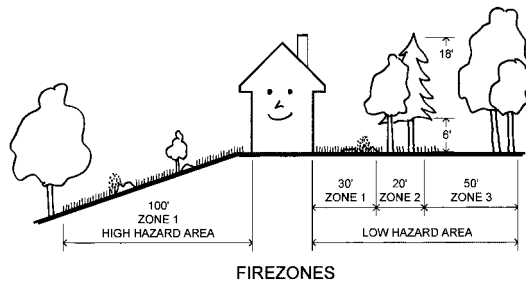

Zone 1: Establish a well-irrigated area around your home. In a low hazard area, it should extend a minimum of 30 feet from your home on all sides. As your hazard risk increases, a clearance of between 50 and 100 feet or more may be necessary, especially on any downhill sides of the lot. Plantings should be limited to carefully spaced indigenous species.

Zone 2 Place low-growing plants, shrubs and carefully spaced trees in this area. Maintain a reduced amount of vegetation. Your irrigation system

should also extend into this area.

Trees should be at least 10 feet apart, and all dead or dying limbs should be trimmed. For trees taller than 18 feet, prune lower branches within six feet of the ground. No tree limbs should come within 10 feet of your home.

Zone 3: This furthest zone from your home is a slightly modified natural area. Thin selected trees and remove highly flammable vegetation such as dead or dying trees and shrubs.

So how far should Zones 2 and 3 extend? Well, that depends upon your risk and your property's boundaries.

In a low hazard area, these two zones should extend another 20 feet or so beyond the 30 feet in Zone 1. This creates a modified landscape of over 50 feet total.

In a moderate hazard area, these two zones should extend at least another 50 feet beyond the 50 feet in Zone 1. This would create a modified landscape of over 100 feet total.

In a high hazard area, these two zones should extend at least another 100 feet beyond the 100 feet in Zone 1. This would create a modified landscape of over 200 feet total.

The Importance of Maintenance

Once you have created your home's survivable space, you must maintain it or risk losing the benefit of its protection.

your home's building materials and design

Creating and maintaining a survivable space is a necessary first step. The next step is to use fire resistant building materials and construction techniques in retrofitting your home.

The Ideal Fire-Resistant Home

Keep in mind that a wildfire sees your home as just another fuel

source. The survivable space you construct around your home will keep all but the most ferocious wildfires at bay. However, if the wildfire does break through your first line of defense, an ignition might occur on your home's exterior. The ideal situation is for your home's exterior materials to prevent or retard the flames from burning into your interior walls, soffits, attic area, and rooms.

Taking Inventory

Examine your home's construction and materials. Use the following as a checklist.

- What type of roof covering do you have? Asphalt, wood, concrete, tile or metal?
- How are your eaves, fascias and soffits constructed? Are they made from vinyl, wood or metal?
- What are your home's exterior walls covered with? Are they wood, aluminum or vinyl siding, stucco, brick or concrete masonry?
- Do you have large windows or sliding glass doors that border or face the wildland? Are they single pane, double pane or tempered glass?
- How are your home's attic and sub-floor vents protected? Are their covers metal or vinyl?
- Are spark arresters installed on all your home's chimneys?
- Does your home have a deck or balcony that overhangs a slope?
- Is there a porch, garage or wood fence that attaches directly to your home?

Taking Action

Now you will need to decide on the best modifications for your home, given your risk.

Roof: The roof is the most vulnerable part of your home to wildfires. During a wildfire, firebrands can fall on your roof, landing in your roof's nooks and crannies where a fire can easily start. Once your roof covering does ignite, chances are very good that the rest of your home will follow.

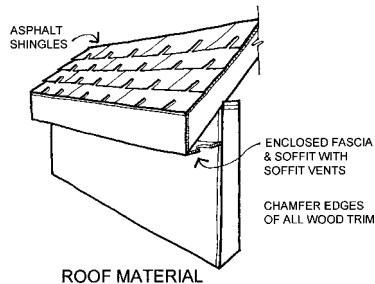
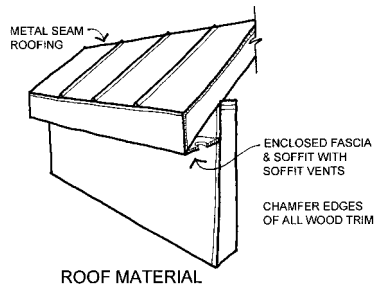

The best way to avoid this situation is to make sure your roof is fire-resistant. The two main fire resistance tests used today include: ASTM E108 and UL 790. There are three levels of classification awarded under the test protocol, A, B, and C, with A being the most

fire resistant. Some treated wood shake shingle products have ratings of Class C or better. Over time, the effectiveness of this chemical is reduced by weathering before the end of the product's useful life and may leave your roof unprotected.

If your roof needs to be re-covered, consider installing a Class A roof covering.

Exterior Walls: Exterior walls are susceptible to a wildfire's radiant and convective heat. Although a fire on an exterior wall may not penetrate inside your home, the fire can 'bridge' to more vulnerable areas such as eaves, soffits, vents and windows.

Wall materials that resist heat and flames include cement, plaster, stucco and concrete masonry such as stone, brick or block. Though some materials will not burn, such as vinyl, they may lose their integrity when exposed to high temperature and fall away or melt, providing the fire with a direct path inside the home.

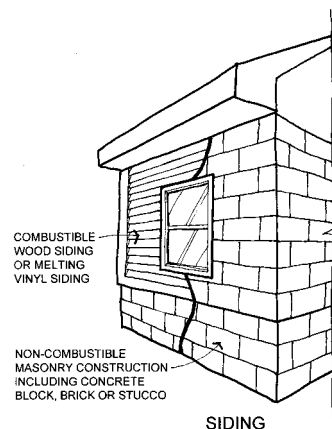

Exterior Windows, Glass Doors and Skylights: Exposure to the heat of the wildfire can cause glass to fracture and collapse, leaving an opening for flames and firebrands to enter your home. This applies to both double pane and single pane glass, since double pane glass is only slightly more resistant to heat than single pane glass.

On the other hand, single or double pane tempered glass windows, doors and skylights typically fracture at higher exposures, well above the radiant heat exposures capable of igniting the surrounding wood.

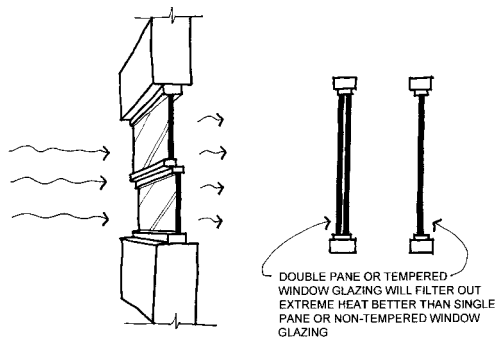

WINDOW GLAZING

Eaves, Fascias, Soffits: Eaves, fascias and soffits are vulnerable to both firebrands and convective exposures.

Eaves, fascias and soffits should be ‘boxed’ or enclosed with noncombustible materials to reduce the size of the vents. Materials that melt or

burn in relatively low temperatures, such as PVC and vinyl siding, should not be used, since they do not provide adequate protection and can melt in the heat of the wildfire. Non-combustible screening should be used in the vents.

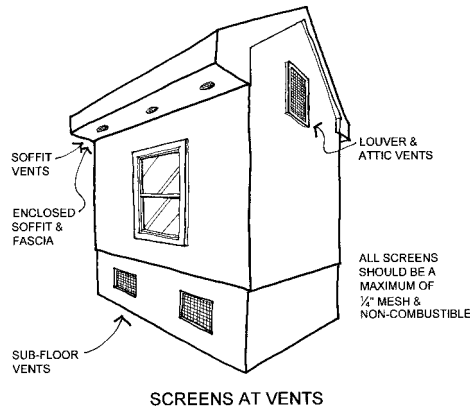

Attic, Subfloor or Foundation Vents: Wind and/or direct contact with a fire’s convective heat can push firebrands through the vents into your home’s basement or crawl space.

Your vent openings should be screened to prevent firebrands or other objects larger than 1/4 inch from entering your home. Both your vents and screens should be constructed of materials that will not burn or melt when exposed to radiate or convective heat or firebrands. Also, these vents should be corrosion-resistant to help minimize required maintenance.

Fireplace Chimneys: Windblown embers can access your home through your fireplace's chimney flue. Once inside, these firebrands then collect on flammable objects, greatly increasing the chance of combustion. The situation can also be reversed: embers from your own fire can fly out the chimney and start a wildfire, right in your own neighborhood.

The best way to avoid this situation is to install a spark arrestor made from welded wire or woven wire mesh with openings less than 1/4" wide.

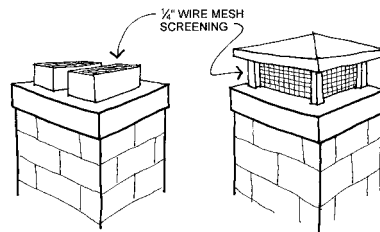

CHIMNEY SCREENS

Overhangs and Other Attachments: Overhangs and other attachments include any additional structures attached to a residence such as room pushouts, bay windows, decks, porches, carports and fences. These features are often very vulnerable to convective exposures.

When assessing your home and property, if the feature in question is attached to your home, it should be considered part of your home.

There are a number of ways you can reduce the vulnerability of your home's overhangs and attachments. First and foremost, remove all fuels around these areas. Next, box in the undersides of the overhangs, decks and balconies with noncombustible or fire-resistant materials to reduce the possibility of ignition. For fences, make sure that they don't attach directly to your home.

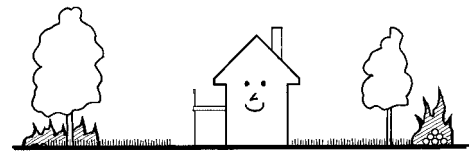

WOOD PILES, DECKS, FENCES, ETC.

helping your local fire department

Even if you modify your home's landscape to incorporate the most fire-resistant materials and design into your home's construction, there is no guarantee that a wildfire will not threaten your home. It is important that your local fire department be able to find and defend your home.

Here are some suggestions on how to modify your property to accommodate your local fire department.

Street Signs and Numbers: If made from combustible materials, your street signs and numbers can ignite or melt, leaving the fire department with no ability to locate your home. It is critical that signs and numbers be noncombustible and visible from the road.

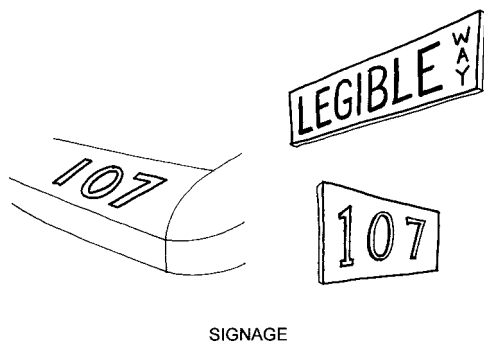

Driveways: Fire trucks and equipment are quite large and often have difficulty in tight spots. Consequently, your home's driveway must be large enough to accommodate the typical sized trucks. Fire experts recommend a driveway at least 12 feet wide and 13 feet of vertical clearance.

Gates: If your home is gated, it is very important that the gate opens inward and be wide enough to accommodate the fire fighting equipment. Experts also recommend that the gate be at least 30 feet off of the main road, so that the equipment can pull off the road to open the gate. If the gate is locked, the lock should not be so strong that firefighters cannot break it in an emergency.

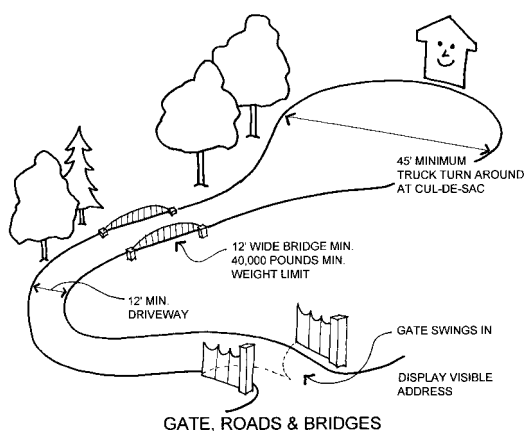

wildfire safety project list

This list of home improvements is divided into cost categories. You can tackle these projects one at a time, but remember, the more you do, the better protected your home will be against wildfires.

Category \$ (<\$300)

- Creating a survivable space;
- Maintaining your survivable space;
- Installing fire-resistant signs and address numbers;
- Modifying your attic, sub-floor, and basement vents;
- Installing a spark arrestor on your chimney.

Category \$\$ (\$300 – \$1000)

- Boxing in overhangs and modifying other attachments;
- Boxing in your eaves, fascias, and soffits.

Category \$\$\$ (>\$1000)







- Re-covering your exterior walls with a more fire-resistant material;
- Replacing single-pane glass windows, doors, or skylights with tempered glass;
- Modifying your driveway, bridges, and gates to accommodate fire trucks.
- Re-roofing your home with a Class A roof covering.

WILDFIRE PROTECTION CHECKLIST











Before, During and After: Be Completely Prepared

You will give yourself and your family a better chance of escaping harm during a wildfire by taking as many of the precautions outlined in this brochure as possible. But, these steps are only the beginning. To protect yourself as completely as possible, here are some added suggestions:











before a wildfire strikes:

	Know where your gas, electric and water main shut-off controls are and how to turn them off if there is a leak or electrical short. Also, know how to use a fire extinguisher. Make sure all adult and teenage members of your family know how to shut off each utility and to use the extinguisher.
	Become familiar with your community's disaster-preparedness plans and create a family plan. Know where the closest police, fire and emergency medical facilities are located.
	Plan several different escape routes from your home and neighborhood and designate an emergency meeting place for the family to reunite. Establish a contact point to communicate with concerned relatives.
	Put together an emergency kit that includes at least a three-day supply of drinking water and food that needs no refrigeration and, generally, no cooking; emergency cooking equipment, if required; a portable NOAA weather radio; first aid supplies and medications; basic tools, such as a wrench, a flashlight and gloves; portable lanterns and batteries; credit cards and cash; and important documents, including insurance policies.
	Talk to your neighbors about wildfire safety. Plan how the neighborhood could work together before, during and after a wildfire. Make a list of your neighbors' skills such as medical or technical. Consider how you would help neighbors who have special needs such as elderly or disabled persons. Make plans to take care of children who may be on their own if parents can't get home.
	Periodically review your homeowner's insurance policy with your insurance agent or company to make sure that, if you are the victim of a disaster, you have enough coverage to rebuild your home and life.





during a wildfire:

	If you are warned that a wildfire is threatening your area, listen to your portable radio for reports and evacuation information. Follow the instructions of local officials.
	Back your car into the garage or park it in an open space facing the direction of escape. Shut car doors and roll up windows. Leave the key in the ignition or in another easily accessible location.
	Close garage windows and doors, but leave them unlocked. Disconnect automatic garage door openers.
	Confine pets to one room. Make plans to care for your pets in case you must evacuate.
	Arrange temporary housing outside the threatened area.
	When advised to evacuate, do so immediately.
	Wear protective clothing – sturdy shoes, cotton or woolen clothing, long pants, a long-sleeved shirt, gloves and a handkerchief to protect your face.
	Take your emergency kit.
	Lock your home.
	Notify your relatives and the local officials that you have left and where you can be reached.
	Follow the evacuation route that your local officials have identified. If no official route exists, choose a route away from fire hazards. Watch for changes in the speed and direction of the fire and smoke.

If you are SURE you have the time, take additional steps to protect your home:

	Close windows, vents, doors, venetian blinds and heavy drapes. Remove lightweight curtains.
	Shut off gas at the meter. Turn off pilot lights.
	Move flammable furniture into the center of the home away from windows and sliding-glass doors.
	Turn on a light in each room to increase the visibility of your home in heavy smoke.
	Seal attic and ground vents.
	Turn off propane tanks.
	Place combustible patio furniture inside.
	Connect the garden hose to outside taps.
	Place lawn sprinklers on the roof and near aboveground fuel tanks. Wet the roof.
	Wet or remove shrubs within 15 feet of the home.
	Gather fire tools, including a rake, axe, hand/chainsaw, bucket and shovel.

after a wildfire strikes:

	Listen to and follow the advice and recommendations of the local aid organizations, including the emergency management office, the fire department and the utility companies.
	Check for hazards, such as gas or water leaks and electrical shorts. Turn off damaged utilities. Have the fire department or gas and electric companies turn the utilities back on when the area is secured.
	Check for injuries and administer first aid as needed.
	Check your food and water supplies. Do not eat anything from open containers near shattered glass.

references

American Society for Testing and Materials. Standard Test Methods for Fire Testing of Roof Coverings ASTM E108. West Conshohocken, PA: ASTM, 2000.

Insurance Services Office, Inc. The Wildland/Urban Fire Hazard. New York, NY: ISO, 1997

International Fire Code Institute Urban-Wildland Interface Code. Whittier, CA: IFCI, 2000

National Fire Protection Association
Firewise Landscaping Videotapes (3) and Checklist. Firewise Construction Videotapes and Checklist. Quincy, MA: NFPA, 1994

- Protecting Your Home from Wildfire. Quincy, MA: NFPA, 1987

- Standard for Protection of Life and Property from Wildfire NFPA 299. 1997 Edition. Quincy, MA: NFPA, 1997.

NFPA Journal
Wildland/Urban Interface Fires. Quincy, MA: NFPA, March/April.

National Wildland/Urban Interface Fire Protection Program. Wildland/Urban Interface Fire Hazard Assessment Methodology. Washington, DC: 1997

Underwriters Laboratories
Tests for Fire Resistance of Roof Covering Materials. UL 790. Northbrook, IL: 1997

Alberta Environment Land and Forest Service
FireSmart: Protecting Your Community from Wildfire. Partners in Protection. Edmonton, Alberta: May 1999.

appendix I: additional sources of information

California Department of Forestry and Fire Protection (CDF)

<http://www.fire.ca.gov/>

Colorado State University/Colorado Forestry Service

<http://lamar.colostate.edu/~firewise/>

Firewise

<http://www.firewise.org/>

National Interagency Fire Center (NIFC)

<http://www.nifc.gov/>

U.S. Forest Service

<http://www.fs.fed.us/fire/>

Wildfire News

<http://www.wildfirenews.com/>



1408 North Westshore Blvd., Suite 208, Tampa, FL 33607
1 (866) 657-IBHS(4247) • Fax (813) 286-9960 • <http://www.ibhs.org/>